

Merry Fisher 1295 FLY



Longueur hors tout / LOA	12,56 m / 41'2"	Capacité eaux noires / Black water capacity	120 L / 32 USgal
Longueur de coque / Hull length	11,92 m / 39'1"	Capacité de froid / Fridge capacity	Max option : 164 L / Min standard :130 L
Largeur maxi / Beam	3,80 m / 12'5"	Cabines / Cabins	Max option : 43,3 USgal / Min standard : 34,34 USgal
Tirant d'air (avec /sans feux de nav) / air draft (w/wo navigation light)	min : 3,88 m / max : 4,97 min: 12'8" / max : 16'3"	Couchages / Berths	3
Tirant d'eau coque / Hull draft	0,77 m / 2'6"	Salles de bain / Heads	6 / 8
Tirant d'eau maxi / Draft max	1,13 m / 3'8"	Motorisation hors-bord max / Outboard engines max	2
Déplacement lège/ Displacement	9 413 kg / 20 752 lbs	Designer & Architecte / Designer & Architect	3 x 300 CV / HP (3 x 221 Kw) + Joystick
Capacité de carburant / Fuel capacity	1200 L / 317 USgal	Catégorie CE / CE certification	Centkowski & Denert Design / Jeanneau Design
Capacité eau / Fresh water capacity	400 L / 105,7 USgal		B 10 / C 12

MERRY FISHER 1295 Fly : THE JOY OF CRUISING

This new Merry Fisher 1295 Fly features multiple living spaces especially designed for relaxation with family and friends. Plenty of time for swimming and moments with your feet dangling in the water from the aft cockpit, with the electrically controlled starboard-side terrace. Port side, a large side door facilitates the access for everyone on board.

With large, bright windows and a panoramic view over the water, life is sweet aboard this flagship, enhanced by a refined, contemporary selection of materials. Take your place at the helm, and take advantage of the very latest technologies, found aboard the largest boats, for easy handling. The starboard-side door will allow easy access and facilitate maneuvers, for cruising with complete peace of mind. Cast off, and take up residence in one of three comfortable cabins, for a peaceful rest on the water at each stop along your cruise !

FLY EXTERIOR

MERRY FISHER
1295 FLY



- New Merry Fisher identity :**
- New shape of hull windows
 - Flybridge outboard: a real motoryacht !

FLY EXTERIOR

MERRY FISHER 1295 FLY

- 1 Large flybridge
- 2 Large glass windows surfaces : a lot of brightness
- 3 Electric terrace (standard)
- 4 Large hull windows (Merry Fisher identity)
- 5 XXL lateral door

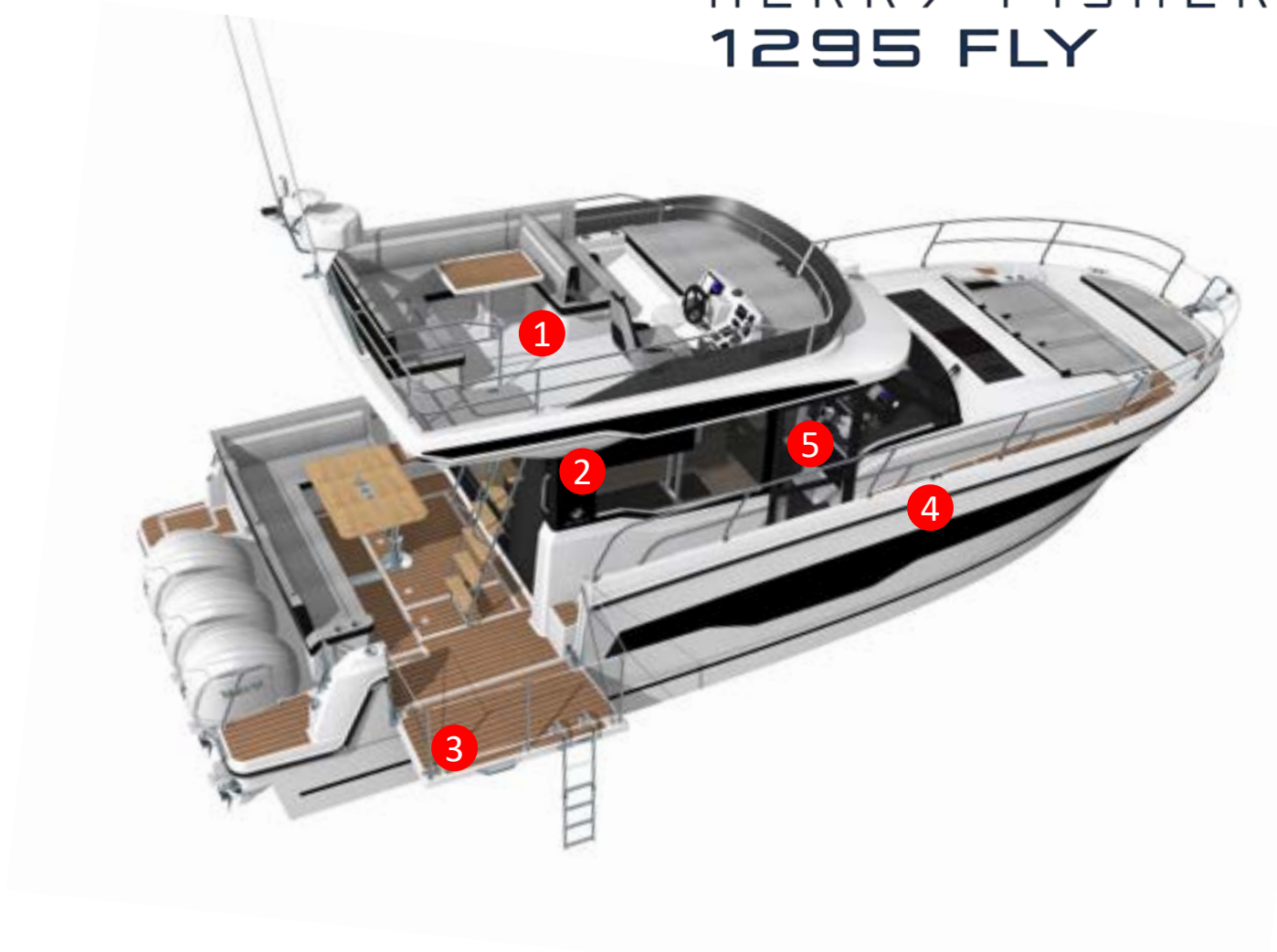

- 1 U-shaped saloon
- 2 Flybridge galley option (sink + grill):
in lieu of the standard seat
- 3 20L drawer fridge (optional)
- 4 Flybridge table (optional)

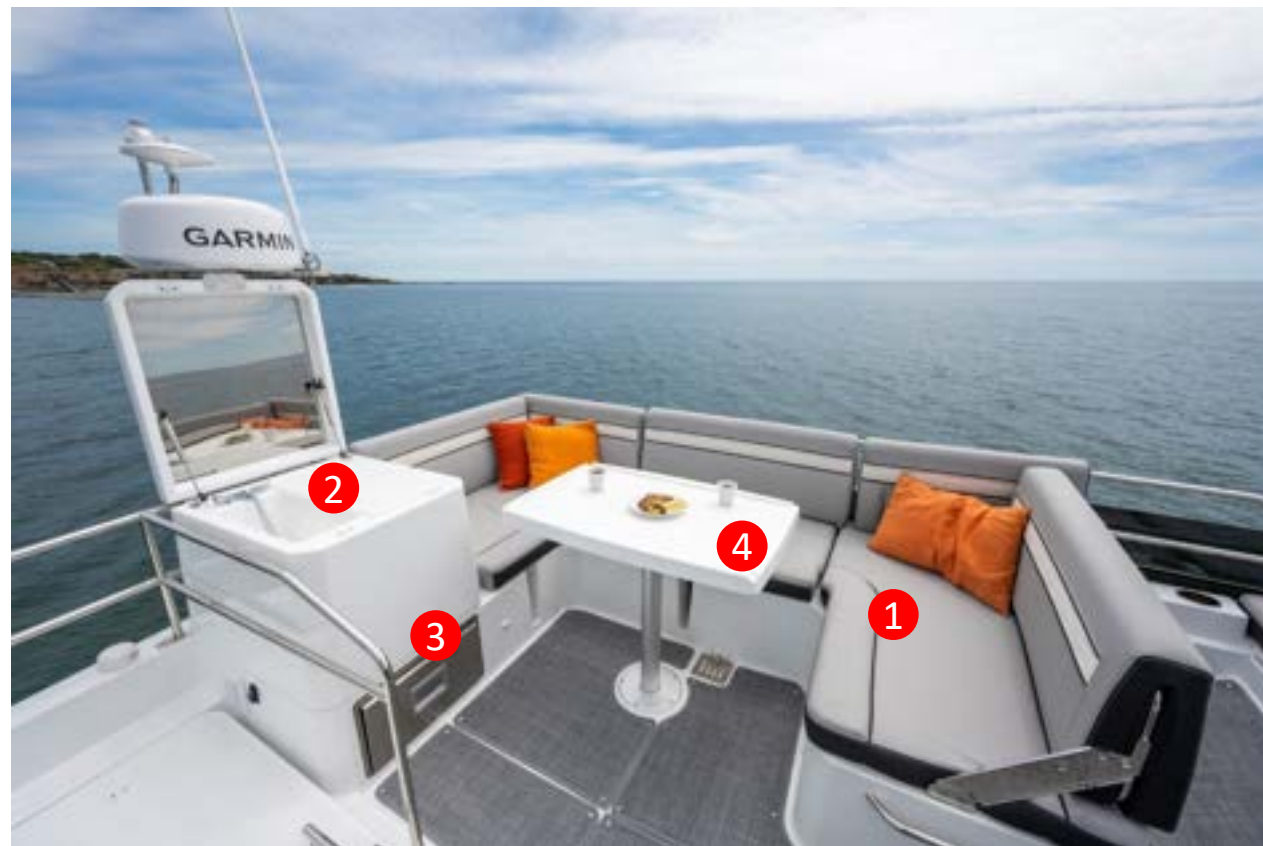

- 1 U-shaped saloon
- 2 Copilot bench with folding backrest, convertible into chaise-longue
- 3 Front sunbed cushions (optional)



FLYBRIDGE

MERRY FISHER
1295 FLY





Cockpit with full instrumentation for engine and accessories
(same as inside instrumentation)

COUPE EXTERIOR

MERRY FISHER
1295

**New Merry Fisher
COUPE:**

A true motor yacht



SPECIFICATIONS

MERRY FISHER 1295 COUPE



Longueur hors tout / LOA

12,56 m / 41'2"

Longueur de coque / Hull length

11,92 m / 39'1"

Largeur maxi / Beam

3,80 m / 12'5"

**Tirant d'air (avec /sans feux de nav) /
air draft (w/wo navigation light)**

min : 3,39 m / max : 4,30
min: 11'1" / max : 14'1"

Tirant d'eau coque / Hull draft

0,9 m / 2'11"

Tirant d'eau maxi / Draft max

1,11 m / 3'8"

Déplacement lège/ Displacement

9 136 kg / 20 136 lbs

Capacité de carburant / Fuel capacity

1200 L / 317 USgal

Capacité eau / Fresh water capacity

400 L / 105,7 USgal

**Capacité eaux noires / Black water
capacity**

120 L / 32 USgal

Capacité de froid / Fridge capacity

Max option : 164 L / Min standard :130 L
Max option : 43,3 USgal /
Min standard : 34,34 USgal

Cabines / Cabins

3

Couchages / Berths

6 / 8

Salles de bain / Heads

2

**Motorisation hors-bord max /
Outboard engines max**

3 x 300 CV / HP (3 x 221 Kw) + Joystick

**Designer & Architecte / Designer &
Architect**

Centkowski & Denert Design / Jeanneau
Design

Catégorie CE / CE certification

B 10 / C 12

EXTERIOR

MERRY FISHER
1295



EXTERIOR

MERRY FISHER
1295



MERRY FISHER 1295 COUPE: THE JOY OF CRUISING

After the successful launch of the Merry Fisher 1295 Flybridge in 2022, Jeanneau announces the launch of the flagship model in a Coupe version.

The new Merry Fisher 1295 Coupe confirms further movement of the brand upmarket. This model has been long-awaited in numerous regions of the world, where it is less sunny or with clearance constraints for cruising. She features all the key strengths of the line: versatility, modular design, space, and clever layouts.

This new model joins the Merry Fisher Weekender line, which ranges from a large outboard cruiser with flybridge to an express version.

Family Cruising

Staying true to its lineage, the Merry Fisher 1295 Coupe benefits from additional comfort, enabling families to extend their stay on the water and experience superb moments of escape year-round, in any weather.

The new comfortable and inviting saloon is bathed in natural light from two opening glass hatches on the wheelhouse roof, providing additional ventilation.

MERRY FISHER 1295 COUPE: THE JOY OF CRUISING

With her three cabins and two head compartments, she features all the elements that make the Merry Fisher 1295 a success: a panoramic view over the water, large, bright windows in the hull, a forward owner's cabin with separate shower, and two guest cabins, either with twin berths or with one large berth.

The U-shaped galley, well-equipped and with ample storage, opens onto the cockpit and exterior living areas, creating an inviting gathering spot. A swivelling pilot seat allows for easy interaction with guests in the saloon, while a cozy sofa, just like at home, encourages shared moments with family and friends.

Attention to detail has been a top priority. The interior fit and finish have been carefully crafted to offer a remarkable quality of life on board, with plush sofa seating for refinement and comfort. A new table with two folding leaves and an electrically adjustable height adds convenience and functionality.

This boat checks all the boxes for enjoying a fun family cruise, with exceptional distinct living areas that ensure everyone's privacy during multi-day outings!

Yachting Style

Our product development team goal was to make handling a 40-foot boat exceptionally easy, putting all the controls all at your fingertips for enhanced accessibility and manoeuvrability.

Taking inspiration from larger yachts, this new model is equipped with options that rival the larger models: joystick, gyroscopic stabiliser, air conditioning, generator, and more.

Her stable hull enables quick planing, for minimal bow rise and level cruising and enjoying comfortable cruises even at reduced speed.

With a high-performance, reliable outboard engines delivering triple 300 HP, the Merry Fisher 1295 Coupe is a safe, secure boat for moments of pure happiness on the water.

Guaranteed Escape from the Everyday

On deck, the new Merry Fisher 1295 Coupe is entirely turned toward the sea.

The electrically controlled side terrace opens to starboard, expanding the spacious aft cockpit, ideal for enjoying a generous life onboard! Portside, the side door facilitates access on board.

Forward, it's time to relax, with the three integrated sun loungers in the cockpit for basking in the sun or unwinding under a large sunshade.

Facing seating and the option to add a table create an inviting atmosphere in this area, accessible in complete safety from the aft cockpit and the helm station via the large starboard side door.

This flagship will win over all those who enjoy cruising with family along the coast, focusing on comfort and relaxation, both inside and out! It offers a new experience for everyone on board: feeling right at home while surrounded by breathtaking scenery.

COUPE EXTERIOR

MERRY FISHER
1295

- ① 2 sliding wheelhouse hatches (standard)
- ② Paddle storage (optional)
- ③ 2 solar panels (optional)
- ④ Large glazed areas: maximum light
- ⑤ Large hull window (new identity)
- ⑥ Electric terrace (standard)

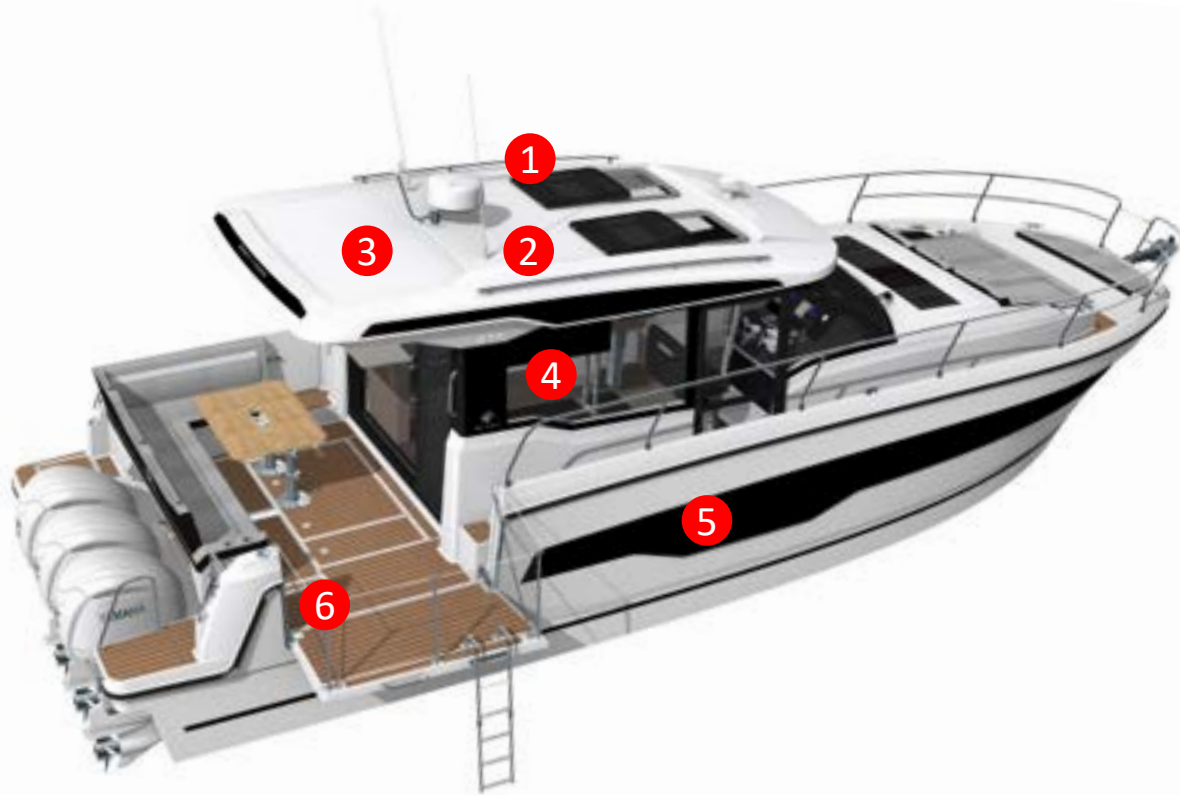

Clear aft cockpit area:

- 1 No fly ladder clutter
- 2 Use of the full width of the patio door
- 3 Easy circulation in the cockpit
- 4 Full opening of the cockpit on the water with the lateral terrace

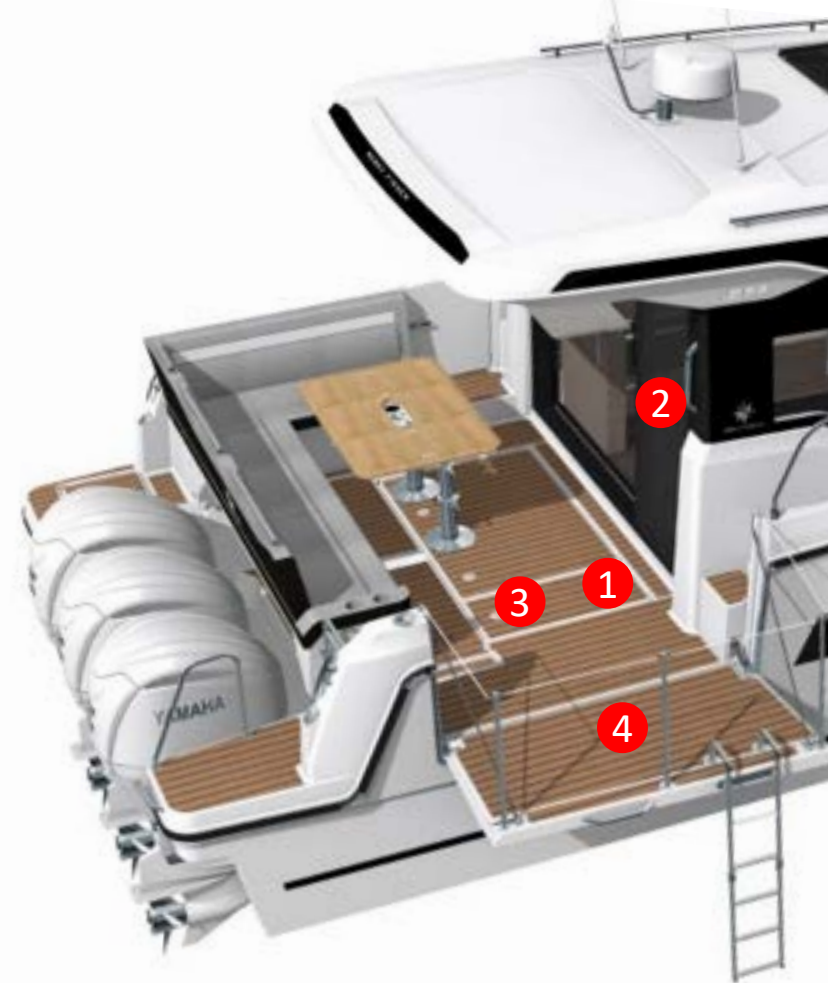

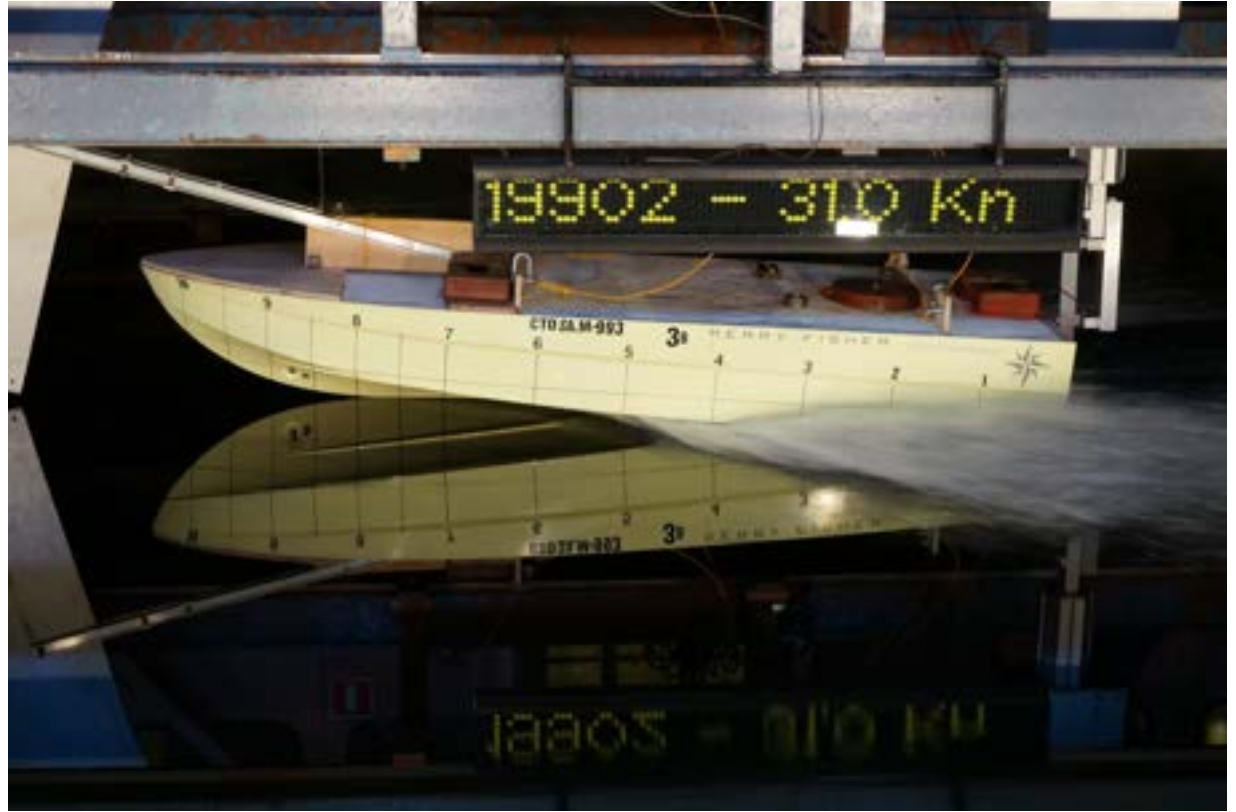

**NEW HULL OPTIMIZED FOR OUTBOARDS AND FLAT CRUISING AT INTERMEDIATE SPEEDS,
IN THE SAME SPIRIT AS THE HULL DEVELOPED FOR THE MERRY FISHER 1095.**

EXTERIOR

MERRY FISHER
1295



1 Side boarding door (on portside)

2 3-leaf bay-window opening to port or starboard

3 Swimming platforms (standard)

4 Hydraulic gangway (optional)

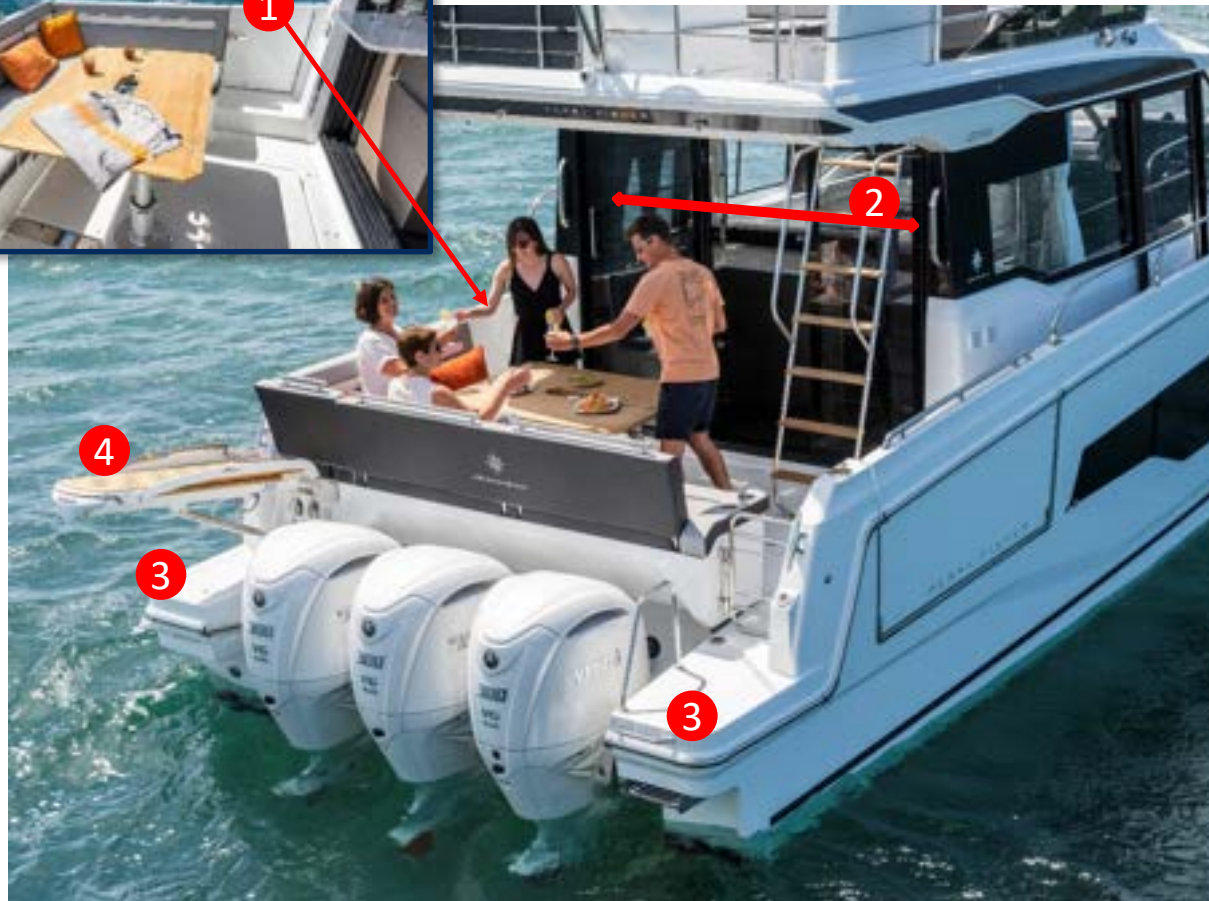

SAFE MANEUVERS & ACCESS ON BOARD



Portside boarding door



Starboard lateral door

① Large aft cockpit

② Large front cockpit/saloon and sunpad

➔ Excellent circulation on board:
Main sidedeck on starboard
Secondary sidedeck on portside



- 1 Main gate
- 2 Storage locker
- 3 Secondary gate
- 4 Aft cockpit table
- 5 Skylight



EXTERIOR

MERRY FISHER 1295

L-shaped cockpit with sliding rear bench, allows :

- Lift up the engines
- Keep the seats
- Easy access to the engines

Secondary gate



Gate :
Easy access

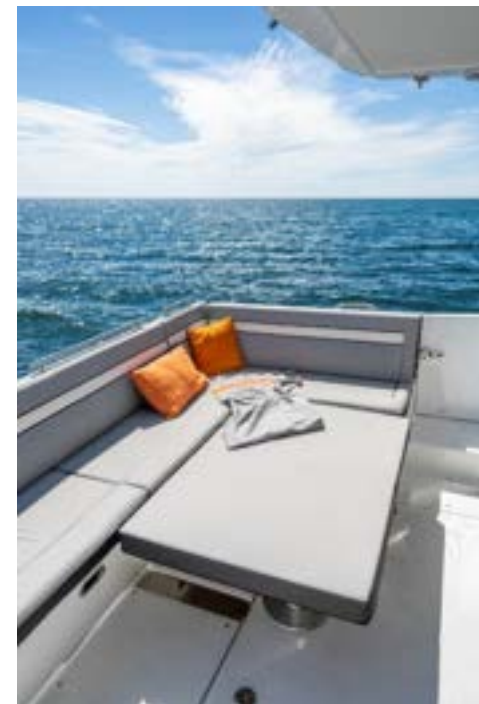

Option: Wood cockpit table - convertible into sunbed

Front cockpit in « vis-à-vis »



Front cockpit in « vis-à-vis »



Front sunbed



XXL front sunbed with filler cushions

GALLEY FACING THE COCKPIT / FACING THE SALOON

- ① Lacquered storage
- ② Folding bar
- ③ Microwave oven (optional)
- ④ Ceramic hob (option to replace gas)
- ⑤ Sink



GALLEY FACING THE COCKPIT / FACING THE SALOON

- 1 2-drawer fridge 130L
or optional:
2-drawer fridge/freezer 144L
- 2 Lacquered storage
- 3 Air conditioning
(optional in lieu of standard storage)
- 4 Pocket folder

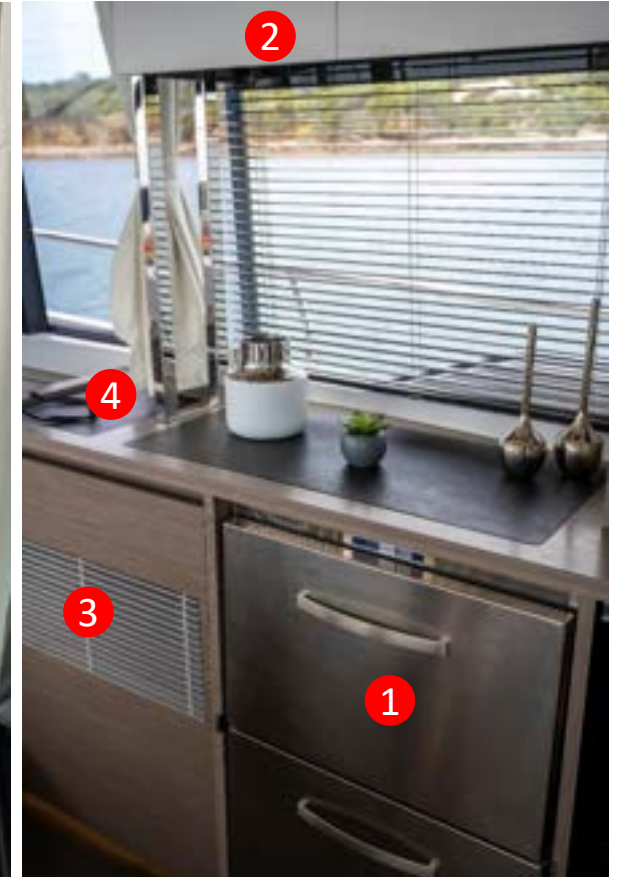

GALLEY FACING THE COCKPIT / FACING THE SALOON



Large storage compartment under the floor of the galley

INTERIOR

Model years 2025 saloon

MERRY FISHER
1295



3D of the saloon from hull 88

INTERIOR

VERY COMFORTABLE SALOON

- 1 Very large saloon
- 2 New table
- 3 Seating in corners
- 4 220v and USB plugs
- 5 Armrests and new backrest design
- 5 Electric table leg (optional)

MERRY FISHER
1295



Photos of the saloon from hull 88

SALON TRES CONFORTABLE

- 1 **Option** : Carré transformable en couchage
- 2 **Option** : Pré-montage TV complet (Carré + cabine avant)
- 3 **Option** : Fauteuil pilote pivotant



Photo ici de l'ancien salon avant la coque 88

VERY COMFORTABLE SALOON

- 1 **Option** : Saloon convertible into a bed
- 2 **Option** : Complete TV prefit (Saloon + front cabin)
- 3 **Option** : Pilot swivel benchseat



- 1 Spacious owner's cabin with private access to the head
- 2 Large en-suite head with shower and separate toilet
- 3 2nd separate cabin with 2 single beds
- 4 3rd separate cabin with 2 single beds
- 5 2nd head with shower and separate toilet

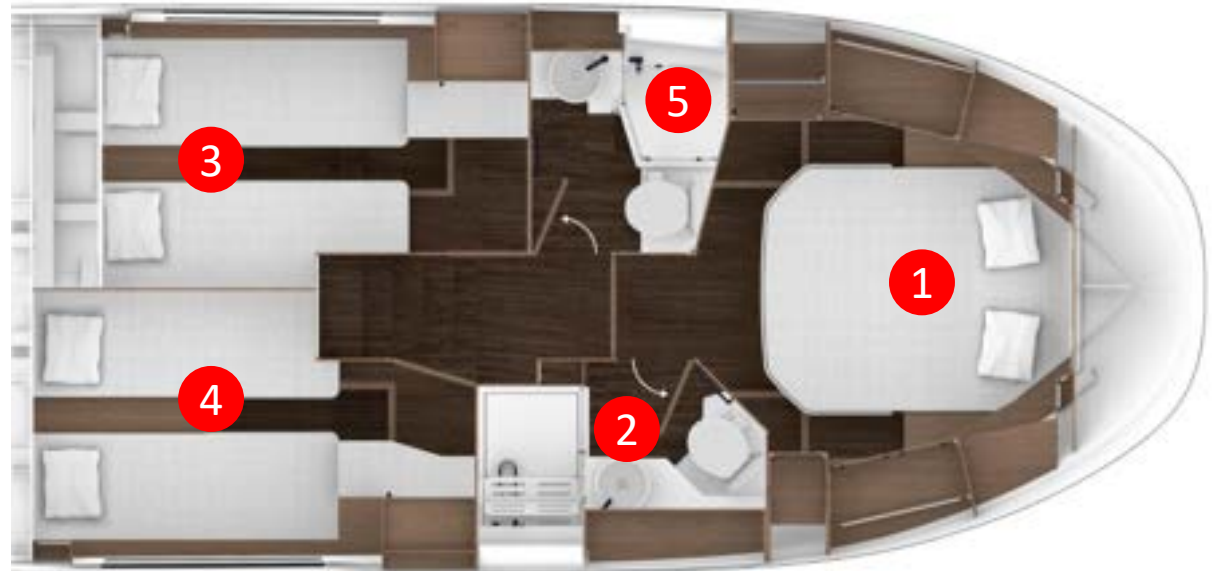

Owner's head

- 1 Separate shower
- 2 Separate toilet
- 3 Storage

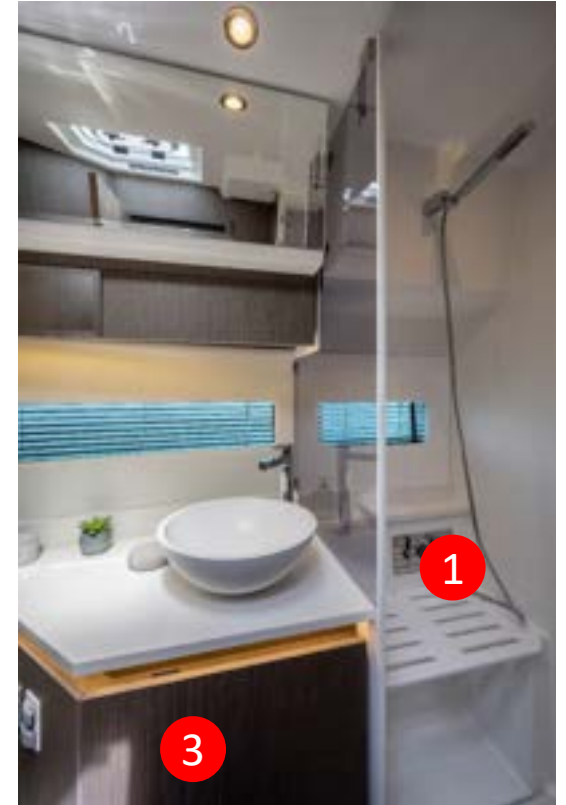

2nd guest head

- 1 Separate shower
- 2 Separate WC
- 3 Storage



LARGE OWNER'S CABIN

- 1 Opening deck panel and Skylight
- 2 Large hull windows
- 3 Lacquered storage
- 4 Large storage under the bed

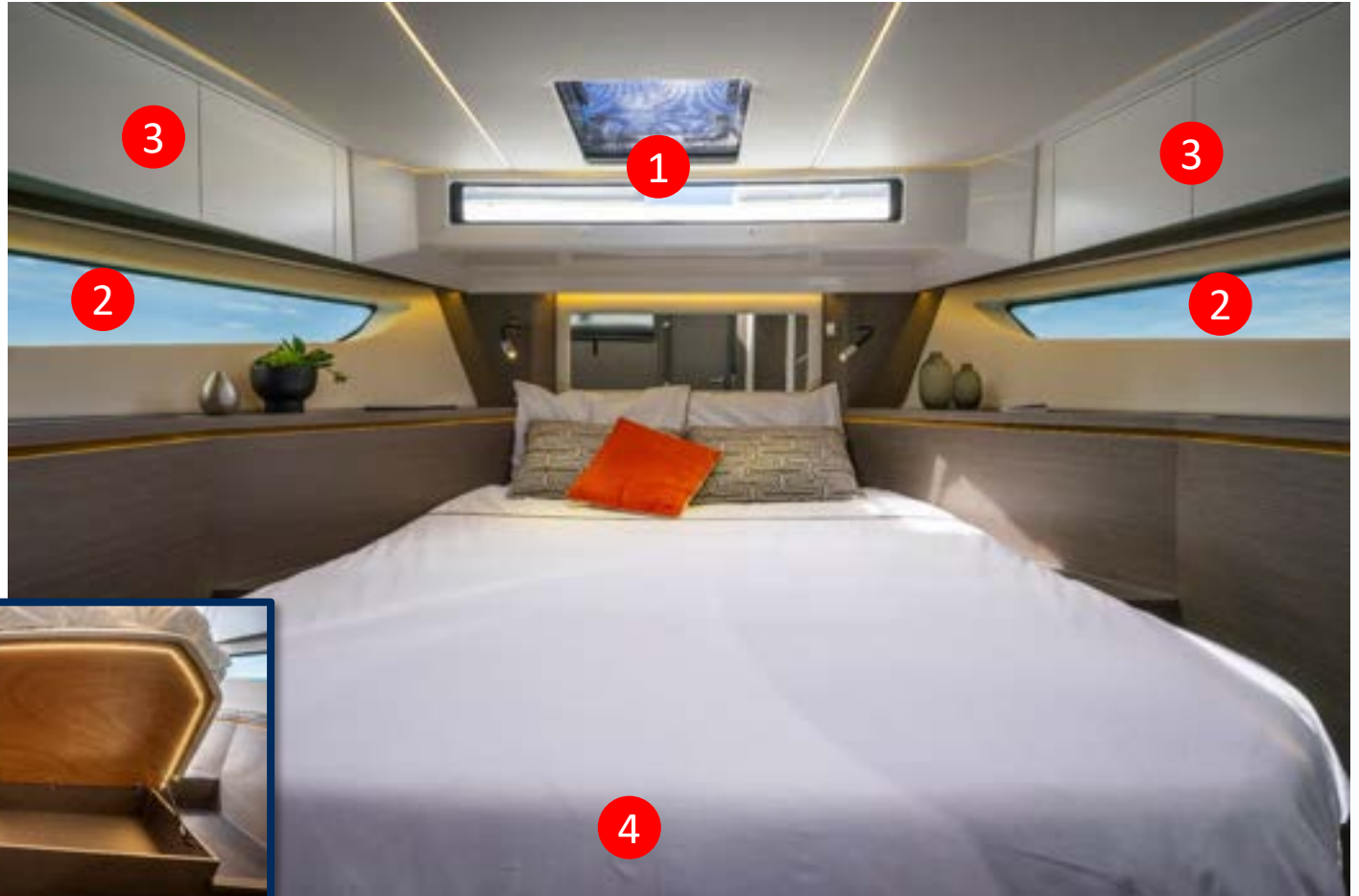

LARGE OWNER'S CABIN

- 1 Wardrobes
- 2 Air conditioning (optional in lieu of standard storage)



2nd GUEST CABIN

- 1 Hull window with opening porthole
- 2 Single beds
- 3 Large wardrobe
- 4 Seating

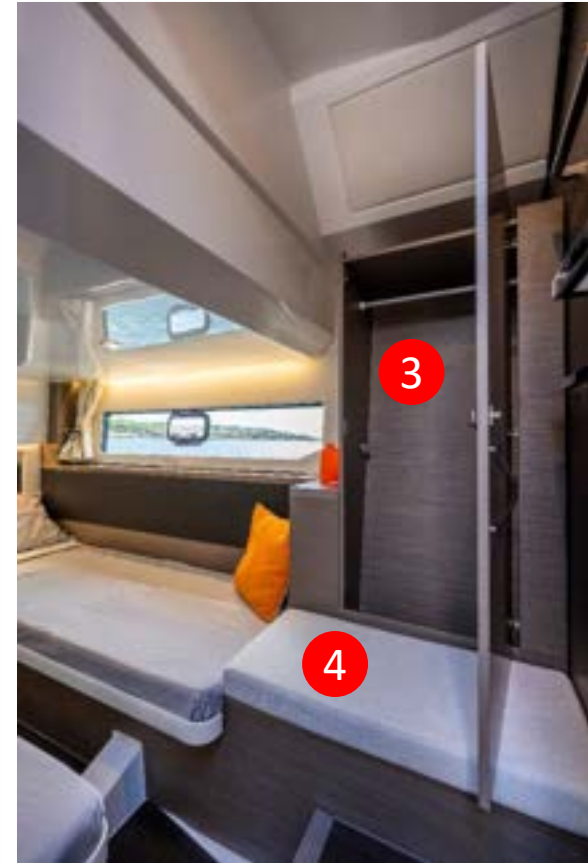

3rd GUEST CABIN

- 1 Hull window with opening porthole
- 2 Single beds
- 3 Large wardrobe
- 4 Seating



ENCLOSURE AND SUN AWNINGS OPTIONS

MERRY FISHER
1295

MERRY FISHER
1295 FLY



Flybridge bimini



Front cockpit sunshade on poles



Cockpit sun awning

Aft cockpit enclosure

EXTERIOR

UPHOLSTERY

STANDARD

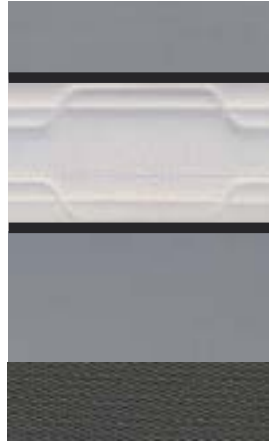

- DIAMANTE MOONLIGHT**
- SPRADLING HITCH ICEBERG**
- DIAMANTE CARBON**

AWNINGS



- SUNBRELLA**
- GRAPHITE**

SUNSHADE

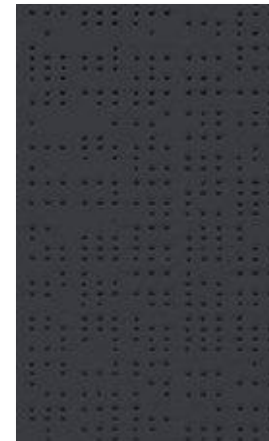

- SOLTIS 92**

INTERIOR

FABRIC INTERIOR

STANDARD



JUMBO PURE

FABRIC INTERIOR

OPTION



TANNERY SUGAR

WOOD



NOYER GRISÉ /
PLANCHER FORTEZZA